

PLOBERGER

SOLUTIONS FOR PROFESSIONALS

Novinka: šrouby v malém balení



Optimax:

Nové praktické krabičky od Plobergeru



shop.ploberger.net

Optimax: nové H-PLUS praktické krabičky od Plobergeru

Ideální pro řemeslo a průmysl...

Mnoho obalů na šrouby je pěkných a relativně dobrých, ale většinou nejsou opravdu praktické, robustní ani šetrné k životnímu prostředí. My ve společnosti Ploberger vyrábíme naše obaly optimalizované pro potřeby kovovýroby, stavebnictví a průmyslu pro použití v dílně a na staveništi. Bezpečné a profesionální skladování.



NOVINKA



s EAN kódem pro rychlé doobjednávání pomocí scanneru



Systemové skladování spojovacího materiálu

Ať už jde o šrouby, standardní díly, spotřební materiál, náradí nebo pracovní ochranu, Ploberger vám dodává nejen všechny tyto produkty, ale také regálové systémy. Rádi za Vás převezmeme a optimalizujeme proces objednávky.



Katalog čárových kódů



E-Shop

profesionální, optimalizovaný a personalizovaný



Plo-Save
výdejní automat



Plo-Shelf
kanban regál



Plo-Scan
online scanner



Plo-Store
výdejní skříň

shop.ploberger.net

Šrouby s vnitřním šestihrannem

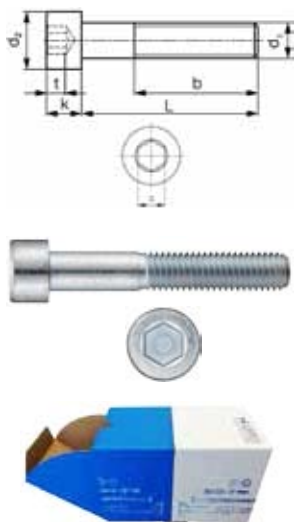

Šroub s válcovou hlavou DIN 912 / ISO 4762 ocel 8,8 poz.

šroub s válcovou hlavou DIN 912/ISO 4762 s vnitřním šestihrannem; ocel 8,8; pozinkováno; metrický závit; VG: plný závit; TG: částečný závit;

rozměr	b mm	d2 mm	s mm	k mm	t mm		obj.č.
M4							
M4 x 8 VG	0,00	7,00	3	4,00	2,00	100	L-K41479
M4 x 10 VG	0,00	7,00	3	4,00	2,00	100	L-K41480
M4 x 12 VG	0,00	7,00	3	4,00	2,00	100	L-K41481
M4 x 16 VG	0,00	7,00	3	4,00	2,00	100	L-K41482
M4 x 20 VG	0,00	7,00	3	4,00	2,00	100	L-K41483
M4 x 25 VG	0,00	7,00	3	4,00	2,00	100	L-K41484
M4 x 30 TG	20,00	7,00	3	4,00	2,00	100	L-K41485
M5							
M5 x 12 VG	0,00	8,50	4	5,00	2,50	100	L-K41486
M5 x 16 VG	0,00	8,50	4	5,00	2,50	100	L-K41487
M5 x 20 VG	0,00	8,50	4	5,00	2,50	100	L-K41488
M5 x 25 VG	0,00	8,50	4	5,00	2,50	100	L-K41489
M5 x 30 TG	22,00	8,50	4	5,00	2,50	100	L-K41490
M5 x 40 TG	22,00	8,50	4	5,00	2,50	100	L-K41491
M5 x 50 TG	22,00	8,50	4	5,00	2,50	100	L-K41492
M6							
M6 x 10 VG	0,00	10,00	5	6,00	3,00	100	L-K41493
M6 x 12 VG	0,00	10,00	5	6,00	3,00	100	L-K41494
M6 x 16 VG	0,00	10,00	5	6,00	3,00	100	L-K41495
M6 x 20 VG	0,00	10,00	5	6,00	3,00	100	L-K41496
M6 x 25 VG	0,00	10,00	5	6,00	3,00	100	L-K41497
M6 x 30 VG	0,00	10,00	5	6,00	3,00	100	L-K41498
M6 x 35 TG	24,00	10,00	5	6,00	3,00	100	L-K41499
M6 x 40 TG	24,00	10,00	5	6,00	3,00	100	L-K41500
M6 x 45 TG	24,00	10,00	5	6,00	3,00	100	L-K41501
M6 x 50 TG	24,00	10,00	5	6,00	3,00	100	L-K41502
M6 x 60 TG	24,00	10,00	5	6,00	3,00	100	L-K41503
M8							
M8 x 12 VG	0,00	13,00	6	8,00	4,00	200	L-K41504
M8 x 16 VG	0,00	13,00	6	8,00	4,00	200	L-K41505
M8 x 20 VG	0,00	13,00	6	8,00	4,00	200	L-K41506
M8 x 25 VG	0,00	13,00	6	8,00	4,00	200	L-K41507
M8 x 30 VG	0,00	13,00	6	8,00	4,00	200	L-K41508
M8 x 35 VG	0,00	13,00	6	8,00	4,00	200	L-K41509
M8 x 40 TG	28,00	13,00	6	8,00	4,00	200	L-K41510
M8 x 45 TG	28,00	13,00	6	8,00	4,00	200	L-K41511
M8 x 50 TG	28,00	13,00	6	8,00	4,00	200	L-K41512
M8 x 60 TG	28,00	13,00	6	8,00	4,00	200	L-K41513
M8 x 70 TG	28,00	13,00	6	8,00	4,00	200	L-K41514
M8 x 80 TG	28,00	13,00	6	8,00	4,00	200	L-K41515
M10							
M10 x 12 VG	0,00	16,00	8	10,00	5,00	200	L-K41516
M10 x 16 VG	0,00	16,00	8	10,00	5,00	200	L-K41517
M10 x 20 VG	0,00	16,00	8	10,00	5,00	200	L-K41518
M10 x 25 VG	0,00	16,00	8	10,00	5,00	200	L-K41519
M10 x 30 VG	0,00	16,00	8	10,00	5,00	200	L-K41520
M10 x 35 VG	0,00	16,00	8	10,00	5,00	100	L-K41521
M10 x 40 VG	0,00	16,00	8	10,00	5,00	100	L-K41522
M10 x 50 TG	32,00	16,00	8	10,00	5,00	100	L-K41523
M10 x 60 TG	32,00	16,00	8	10,00	5,00	100	L-K41524
M10 x 80 TG	32,00	16,00	8	10,00	5,00	100	L-K41525
M10 x 100 TG	32,00	16,00	8	10,00	5,00	50	L-K41526
M10 x 120 TG	32,00	16,00	8	10,00	5,00	50	L-K41527
M12							
M12 x 20 VG	0,00	18,00	10	12,00	6,00	50	L-K41528
M12 x 25 VG	0,00	18,00	10	12,00	6,00	50	L-K41529
M12 x 30 VG	0,00	18,00	10	12,00	6,00	50	L-K41531
M12 x 35 VG	0,00	18,00	10	12,00	6,00	50	L-K41532
M12 x 40 VG	0,00	18,00	10	12,00	6,00	50	L-K41533
M12 x 50 VG	0,00	18,00	10	12,00	6,00	50	L-K41534
M12 x 60 TG	36,00	18,00	10	12,00	6,00	50	L-K41535
M12 x 80 TG	36,00	18,00	10	12,00	6,00	50	L-K41536
M12 x 100 TG	36,00	18,00	10	12,00	6,00	50	L-K41537
M12 x 120 TG	36,00	18,00	10	12,00	6,00	50	L-K41538

Aktuální ceny a akce na: shop.ploberger.net

Optimax: nové H-PLUS praktické krabičky od Plobergeru!

NOVINKA



Šrouby s šestihrannou hlavou

Šroub s šestihrannou hlavou DIN 933 / ISO 4017 ocel 8,8 poz.

šroub s šestihrannou hlavou DIN 933 / ISO 4017 ocel 8,8; pozinkováno; bez stopky; VG: plný závit; TG: částečný závit;

rozměr	s mm	e mm	k mm		obj.č.
M4					
M4 x 6 VG	7	7,66	2,80	200	L-K41568
M4 x 8 VG	7	7,66	2,80	200	L-K41569
M4 x 10 VG	7	7,66	2,80	200	L-K41570
M4 x 12 VG	7	7,66	2,80	200	L-K41571
M4 x 16 VG	7	7,66	2,80	200	L-K41572
M4 x 20 VG	7	7,66	2,80	200	L-K41573
M4 x 25 VG	7	7,66	2,80	200	L-K41574
M4 x 30 VG	7	7,66	2,80	200	L-K41576
M5					
M5 x 8 VG	8	8,79	3,50	200	L-K41578
M5 x 10 VG	8	8,79	3,50	200	L-K41579
M5 x 12 VG	8	8,79	3,50	200	L-K41580
M5 x 16 VG	8	8,79	3,50	200	L-K41581
M5 x 20 VG	8	8,79	3,50	200	L-K41582
M5 x 25 VG	8	8,79	3,50	200	L-K41583
M5 x 30 VG	8	8,79	3,50	200	L-K41584
M5 x 40 VG	8	8,79	3,50	200	L-K41585
M6					
M6 x 10 VG	10	11,05	4,00	200	L-K41586
M6 x 12 VG	10	11,05	4,00	200	L-K41587
M6 x 16 VG	10	11,05	4,00	200	L-K41588
M6 x 20 VG	10	11,05	4,00	200	L-K41589
M6 x 25 VG	10	11,05	4,00	200	L-K41590
M6 x 30 VG	10	11,05	4,00	200	L-K41591
M6 x 40 VG	10	11,05	4,00	200	L-K41592
M6 x 50 VG	10	11,05	4,00	200	L-K41593
M8					
M8 x 12 VG	13	14,38	5,30	200	L-K41594
M8 x 16 VG	13	14,38	5,30	200	L-K41595
M8 x 20 VG	13	14,38	5,30	200	L-K41596
M8 x 25 VG	13	14,38	5,30	200	L-K41597
M8 x 30 VG	13	14,38	5,30	200	L-K41598
M8 x 35 VG	13	14,38	5,30	200	L-K41599
M8 x 40 VG	13	14,38	5,30	200	L-K41600
M8 x 45 VG	13	14,38	5,30	200	L-K41601
M8 x 50 VG	13	14,38	5,30	200	L-K41602
M8 x 60 VG	13	14,38	5,30	200	L-K41603
M16					
M16 x 30 VG	24	26,75	10,00	50	L-K41627
M16 x 35 VG	24	26,75	10,00	50	L-K41628
M16 x 40 VG	24	26,75	10,00	50	L-K41629
M16 x 45 VG	24	26,75	10,00	50	L-K41630
M16 x 50 VG	24	26,75	10,00	25	L-K41631
M16 x 55 VG	24	26,75	10,00	25	L-K41632
M16 x 60 VG	24	26,75	10,00	25	L-K41633
M16 x 65 VG	24	26,75	10,00	25	L-K41634
M16 x 70 VG	24	26,75	10,00	25	L-K41635
M16 x 75 VG	24	26,75	10,00	25	L-K41636
M16 x 80 VG	24	26,75	10,00	25	L-K41637
M16 x 90 VG	24	26,75	10,00	25	L-K41638
M16 x 100 VG	24	26,75	10,00	25	L-K41639
M20					
M20 x 50 VG	30	33,53	12,50	25	L-K41640
M20 x 60 VG	30	33,53	12,50	25	L-K41641
M20 x 70 VG	30	33,53	12,50	25	L-K41642
M20 x 80 VG	30	33,53	12,50	25	L-K41643



ŠROUBY S ŠESTIHRANNOU HLAVOU



Šroub s šestihrannou hlavou ISO 4017 ocel 8,8 poz.

metrický šroub z oceli se šestihrannou hlavou; VG: plný závit; TG: částečný závit;

rozměr	s mm	e mm	k mm		obj.č.
M10					
M10 x 20 VG	16	17,77	6,40	200	L-K41604
M10 x 25 VG	16	17,77	6,40	200	L-K41605
M10 x 30 VG	16	17,77	6,40	200	L-K41606
M10 x 35 VG	16	17,77	6,40	100	L-K41607
M10 x 40 VG	16	17,77	6,40	100	L-K41608
M10 x 45 VG	16	17,77	6,40	100	L-K41609
M10 x 50 VG	16	17,77	6,40	100	L-K41610
M10 x 60 VG	16	17,77	6,40	100	L-K41611
M10 x 80 VG	16	17,77	6,40	100	L-K41612
M12					
M12 x 20 VG	18	20,03	7,50	100	L-K41613
M12 x 25 VG	18	20,03	7,50	100	L-K41614
M12 x 30 VG	18	20,03	7,50	50	L-K41615
M12 x 35 VG	18	20,03	7,50	50	L-K41616
M12 x 40 VG	18	20,03	7,50	50	L-K41617
M12 x 45 VG	18	20,03	7,50	50	L-K41618
M12 x 50 VG	18	20,03	7,50	50	L-K41619
M12 x 55 VG	18	20,03	7,50	50	L-K41620
M12 x 60 VG	18	20,03	7,50	50	L-K41621
M12 x 65 VG	18	20,03	7,50	50	L-K41622
M12 x 70 VG	18	20,03	7,50	50	L-K41623
M12 x 80 VG	18	20,03	7,50	50	L-K41624
M12 x 90 VG	18	20,03	7,50	50	L-K41625
M12 x 100 VG	18	20,03	7,50	50	L-K41626

Aktuální ceny a akce na: shop.ploberger.net

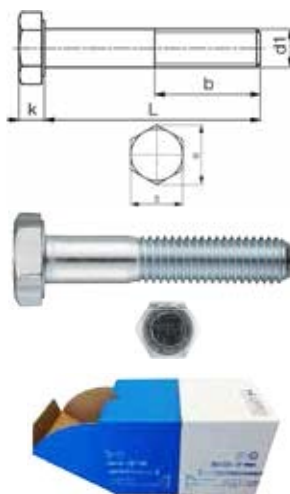

Šroub s šestihrannou hlavou DIN 931 / ISO 4014 ocel 8,8 poz.

šroub s šestihrannou hlavou DIN 933 / ISO 4017 ocel 8,8; pozink; se stopkou; VG: plný závit; TG: částečný závit;

rozměr	b mm	s mm	e mm	k mm		obj.č.
M8						
M8 x 40 TG	22,00	13	14,38	5,30	200	L-K41539
M8 x 50 TG	22,00	13	14,38	5,30	200	L-K41540
M8 x 60 TG	22,00	13	14,38	5,30	200	L-K41541
M8 x 70 TG	22,00	13	14,38	5,30	100	L-K41542
M8 x 80 TG	22,00	13	14,38	5,30	100	L-K41543
M16						
M16 x 60 TG	38,00	24	26,75	10,00	25	L-K41561
M16 x 70 TG	38,00	24	26,75	10,00	25	L-K41562
M16 x 80 TG	38,00	24	26,75	10,00	25	L-K41563
M16 x 90 TG	38,00	24	26,75	10,00	25	L-K41564
M16 x 100 TG	38,00	24	26,75	10,00	25	L-K41565
M16 x 120 TG	38,00	24	26,75	10,00	25	L-K41566
M16 x 140 TG	44,00	24	26,75	10,00	25	L-K41567



Šroub s šestihrannou hlavou ISO 4014 ocel 8.8 poz.

metrický šroub z oceli se šestihrannou hlavou a stopkou; VG: plný závit; TG: částečný závit;

rozměr	b mm	s mm	e mm	k mm		obj.č.
M10						
M10 x 40 TG	26,00	16	17,77	6,40	100	L-K41544
M10 x 50 TG	26,00	16	17,77	6,40	100	L-K41545
M10 x 60 TG	26,00	16	17,77	6,40	100	L-K41546
M10 x 70 TG	26,00	16	17,77	6,40	100	L-K41548
M10 x 80 TG	26,00	16	17,77	6,40	100	L-K41550
M10 x 90 TG	26,00	16	17,77	6,40	100	L-K41551
M10 x 100 TG	26,00	16	17,77	6,40	100	L-K41552
M12						
M12 x 50 TG	30,00	18	20,03	7,50	100	L-K41553
M12 x 60 TG	30,00	18	20,03	7,50	100	L-K41554
M12 x 70 TG	30,00	18	20,03	7,50	50	L-K41555
M12 x 80 TG	30,00	18	20,03	7,50	50	L-K41556
M12 x 90 TG	30,00	18	20,03	7,50	50	L-K41557
M12 x 100 TG	30,00	18	20,03	7,50	50	L-K41558
M12 x 120 TG	30,00	18	20,03	7,50	50	L-K41559
M12 x 140 TG	30,00	18	20,03	7,50	50	L-K41560

Šrouby do plechu, samořezné šrouby

Šroub do plechu samořezný se zápustnou hlavou KS-H DIN 7504P ocel poz.

šroub samořezný z oceli se zápustnou hlavou, křížový; H Phillips nebo vnitřní šestihran (TX); DIN 7504 P; pozinkováno; VG: plný závit, TG: částečný závit;

rozměr	velikost PH	d2 mm	k mm	m mm	tloušťka plechu mm		obj.č.
4,80 mm							
4,8 x 32 VG	2	9,50	3,00	5,10	1,75 - 4,40	500	L-K41718
4,8 x 38 VG	2	9,50	3,00	5,10	1,75 - 4,40	500	L-K41719
4,8 x 50 VG	2	9,50	3,00	5,10	1,75 - 4,40	500	L-K41720

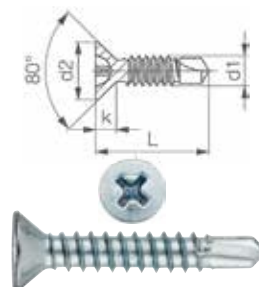

Matice, závitové vložky

Matice šestihránná DIN 934 / ISO 4032 ocel 8 poz.

matice šestihránná z oceli s vnitřním závitem dle normy DIN 934 / ISO 4032; pozinkováno; ocel 8;

d1 mm	s mm	e mm	m mm		obj.č.
M3 / DIN 934, standard KP 500 ks	5,5	6,01	2,40	500	L-K41649
M4 / DIN 934, standard KP 500 ks	7	7,66	3,20	500	L-K41650
M5 / DIN 934, standard KP 500 ks	8	8,79	4,00	500	L-K41651
M6 / DIN 934, standard KP 500 ks	10	11,05	5,00	500	L-K41652
M8 / DIN 934, standard KP 100 ks	13	14,38	6,50	100	L-K41653
M10 / DIN 934, standard KP 100 ks	17	18,90	8,00	100	L-K41654
M12 / DIN 934, standard KP 100 ks	19	21,10	10,00	100	L-K41655
M14 / DIN 934, standard KP 100 ks	22	24,49	11,00	100	L-K41656
M16 / DIN 934, standard KP 100 ks	24	26,75	13,00	100	L-K41657
M20 / DIN 934, standard KP 25 ks	30	32,95	16,00	25	L-K41658
M24 / DIN 934, standard KP 25 ks	36	39,55	19,00	25	L-K41659
M30 / DIN 934, standard KP 5 ks	46	50,85	24,00	5	L-K41660

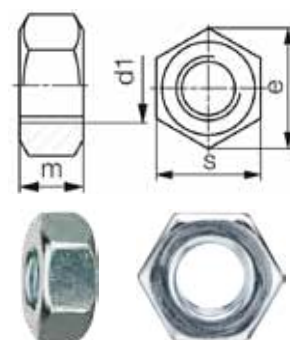

Optimax: nové H-PLUS praktické krabičky od Plobergeru!

NOVINKA



Matice šestihránná kloboučková DIN 1587 ocel 6 poz.

matice šestihránná kloboučková z oceli s vysokým tvarem, DIN 1587; ocel 6; pozinkovaná;

d1 mm	s mm	e mm	h mm	t mm	norma		obj.č.
M6	10	11,05	12,00	8,29	DIN 1587	100	L-K41644
M8	13	14,38	15,00	11,35	DIN 1587	50	L-K41645
M10	17	18,90	18,00	13,35	DIN 1587	50	L-K41646
M12	19	21,10	22,00	16,35	DIN 1587	50	L-K41647
M16	24	26,75	28,00	21,42	DIN 1587	25	L-K41648



Matice pojistná DIN 985 / ISO 10511 ocel 8 poz.

pojistná matice z oceli s nízkým tvarem; DIN 985; s polyamidovou vložkou; ocel 8; pozinkovaná;

d1 mm	s mm	e mm	h mm	m mm		obj.č.
M4	7	7,66	5,00	2,90	500	L-K41661
M5	8	8,79	5,00	3,20	500	L-K41662
M6	10	11,05	6,00	4,00	500	L-K41663
M8	13	14,38	8,00	5,50	500	L-K41664
M10	17	18,90	10,00	6,50	100	L-K41665
M12	19	21,10	12,00	8,00	100	L-K41666
M16	24	26,75	16,00	10,50	100	L-K41667



PODLOŽKY A POJISTNÉ PRVKY

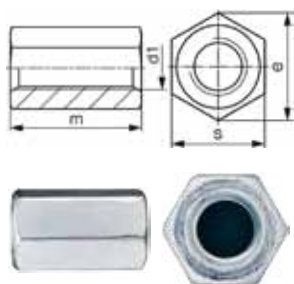

Matice šestihranná prodlužovací ocel poz.

prodlužovací matice 3 d vysoká; šestihranná; ocel; pozinkovaná;

d1 mm	s mm	e mm	m mm		obj.č.
M8	13	15,00	24,00	100	L-K41668
M10	17	19,60	30,00	100	L-K41669
M12	19	21,90	36,00	50	L-K41670
M16	24	27,70	48,00	25	L-K41671

Podložky a pojistné prvky

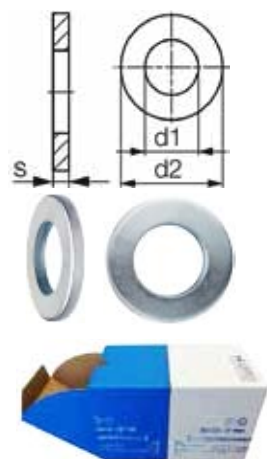

Podložka DIN 125A / ISO 7089 140HV ocel poz.

podložka DIN 125 A ISO 7089; bez fazety; ocel; pozinkované; tvrdost: 140 HV;

pro šrouby	d1 mm	d2 mm	s mm		obj.č.
M3	3,2	7,00	0,5	1000	L-K41696
M4	4,3	9,00	0,8	1000	L-K41697
M5	5,3	10,00	1	1000	L-K41698
M6	6,4	12,00	1,6	1000	L-K41699
M8	8,4	16,00	1,6	1000	L-K41700
M10	10,5	20,00	2	500	L-K41701
M12	13	24,00	2,5	500	L-K41702
M14	15	28,00	2,5	500	L-K41703
M16	17	30,00	3	500	L-K41704
M20	21	37,00	3	200	L-K41705
M24	25	44,00	4	100	L-K41706
M30	31	56,00	4	50	L-K41707

Optimax: nové H-PLUS praktické krabičky od Plobergeru!

NOVINKA

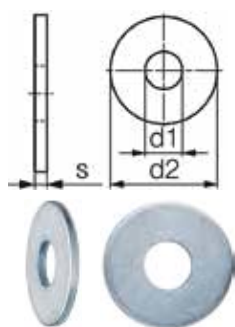

Podložka DIN 9021 / ISO 7093 140HV ocel poz.

podložka DIN 9021 ISO 7093; ocel; pozinkovaná; vnější-Ø = 3 x Ø šroubu; tvrdost: 140 HV;

pro šrouby	d1 mm	d2 mm	s mm		obj.č.
M6	6,4	18,00	1,6	200	L-K41692
M8	8,4	24,00	2	200	L-K41693
M10	10,5	30,00	2,5	200	L-K41694
M12	13	37,00	3	100	L-K41695

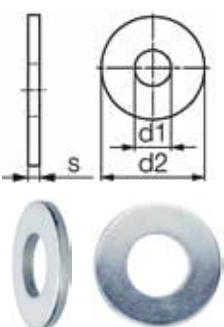

Podložka DIN 134 ocel poz.

podložka DIN 134; s trochu větším vnějším průměrem; ocel; pozinkovaný;

pro šrouby	d1 mm	d2 mm	s mm		obj.č.
M6	6,4	14,00	1,5	500	L-K41708
M8	8,4	18,00	2	500	L-K41709
M10	10,5	22,00	2,5	500	L-K41710
M12	13	28,00	3	200	L-K41711
M14	15	28,00	3	200	L-K41712
M16	17	34,00	3	200	L-K41713

Podložka ISO 7094 ocel poz.

podložka ISO 7094; převážně pro dřevěné konstrukce; kruhový otvor; ocel; pozinkováno;

pro šrouby	d1 mm	d2 mm	s mm		obj.č.
M8	9	28,00	3	200	L-K41688
M10	11	34,00	3	200	L-K41689
M12	13,5	44,00	4	200	L-K41690
M16	17,5	56,00	5	100	L-K41691



Podložka DIN 1052 ocel poz.

podložka DIN 1052; převážně pro dřevěné konstrukce; ocel; pozinkováno;

pro šrouby	d1 mm	d2 mm	s mm		obj.č.
M12	13	58,00	6	50	L-K41715
M16	19	68,00	6	50	L-K41716
M20	23	80,00	8	25	L-K41717



Podložka ocel poz.

podložka; tenké provedení; ocel; pozinkováno; pro šrouby / d1 x d2 x s mm;

pro šrouby		obj.č.
M5 / 5,3 x 20 x 1,25 mm	100	L-K41679
M6 / 6,4 x 20 x 1,25 mm	100	L-K41680
M6 / 6,4 x 25 x 1,25 mm	100	L-K41681
M6 / 6,4 x 30 x 1,25 mm	100	L-K41682
M8 / 8,4 x 20 x 1,25 mm	100	L-K41683
M8 / 8,4 x 25 x 1,25 mm	100	L-K41684
M8 / 8,4 x 30 x 1,25 mm	100	L-K41685
M10 / 10,5 x 30 x 1,25 mm	100	L-K41686
M12 / 13 x 40 x 1,25 mm	100	L-K41687



Podložka DIN 436 ocel poz.

podložka DIN 436; převážně pro dřevěné konstrukce; čtyřhran; ocel; pozinkováno;

pro šrouby	d1 mm	a mm	s mm		obj.č.
M16	17,5	50,00	5	100	L-K41714



Podložka pružná DIN 127B pružinová ocel poz.

podložka pružná DIN 127 B; konce lesklé; pružinová ocel; pozinkováno;

pro šrouby	d1 mm	d2 mm	s mm		obj.č.
M5	5,1	9,20	1,2	100	L-K41672
M6	6,1	11,80	1,6	100	L-K41673
M8	8,1	14,80	2	100	L-K41674
M10	10,2	18,10	2,2	100	L-K41675
M12	12,2	21,10	2,5	100	L-K41676
M16	16,2	27,40	3,5	100	L-K41677
M20	20,2	33,60	4	50	L-K41678



Optimax: nové H-PLUS praktické krabičky od Plobergeru!

NOVINKA



Nerezový spojovací materiál



NEREZ-A2

Šroub s válcovou hlavou ISK DIN 912 / ISO 4762 ušlechtilá ocel A2

šroub s válcovou hlavou DIN 912 ISO 4762; s vnitřním šestihranem; ušlechtilá ocel A2; VG: plný závit, TG: částečný závit;

rozměr	b mm	s mm	k mm	t mm	dk mm		obj.č.
M4							
M4 x 10 VG	0,00	3	4,00	2,00	7,00	200	L-K41752
M4 x 16 VG	0,00	3	4,00	2,00	7,00	200	L-K41753
M4 x 20 VG	0,00	3	4,00	2,00	7,00	200	L-K41754
M4 x 25 VG	0,00	3	4,00	2,00	7,00	200	L-K41755
M5							
M5 x 10 VG	0,00	4	5,00	2,50	8,50	100	L-K41756
M5 x 12 VG	0,00	4	5,00	2,50	8,50	100	L-K41757
M5 x 16 VG	0,00	4	5,00	2,50	8,50	100	L-K41758
M5 x 20 VG	0,00	4	5,00	2,50	8,50	100	L-K41759
M6							
M6 x 10 VG	0,00	5	6,00	3,00	10,00	100	L-K41760
M6 x 12 VG	0,00	5	6,00	3,00	10,00	100	L-K41761
M6 x 16 VG	0,00	5	6,00	3,00	10,00	100	L-K41762
M6 x 20 VG	0,00	5	6,00	3,00	10,00	100	L-K41763
M6 x 25 VG	0,00	5	6,00	3,00	10,00	100	L-K41764
M6 x 30 VG	0,00	5	6,00	3,00	10,00	100	L-K41765
M6 x 40 TG	24,00	5	6,00	3,00	10,00	100	L-K41766
M8							
M8 x 16 VG	0,00	6	8,00	4,00	13,00	100	L-K41767
M8 x 20 VG	0,00	6	8,00	4,00	13,00	100	L-K41768
M8 x 25 VG	0,00	6	8,00	4,00	13,00	100	L-K41769
M8 x 30 VG	0,00	6	8,00	4,00	13,00	100	L-K41770
M10							
M10 x 30 VG	0,00	8	10,00	5,00	16,00	100	L-K41771

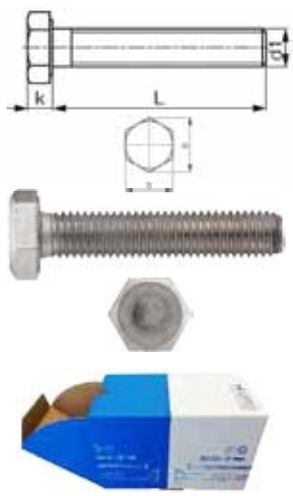

NEREZ-A2

Šroub se šestihrannou hlavou DIN 933 / ISO 4017 ušlechtilá ocel A2

šroub se šestihrannou hlavou DIN 933, ISO 4017; bez kolíku; ušlechtilá ocel A2; VG: plný závit, TG: částečný závit;

rozměr	s mm	k mm	e mm	norma		obj.č.
M6						
M6 x 16 VG	10	4,00	11,05	DIN 933 / ISO 4017	200	L-K41735
M6 x 20 VG	10	4,00	11,05	DIN 933 / ISO 4017	200	L-K41736
M6 x 25 VG	10	4,00	11,05	DIN 933 / ISO 4017	200	L-K41737
M6 x 30 VG	10	4,00	11,05	DIN 933 / ISO 4017	200	L-K41738
M8						
M8 x 16 VG	13	5,30	14,38	DIN 933 / ISO 4017	100	L-K41739
M8 x 20 VG	13	5,30	14,38	DIN 933 / ISO 4017	100	L-K41740
M8 x 25 VG	13	5,30	14,38	DIN 933 / ISO 4017	100	L-K41741
M8 x 30 VG	13	5,30	14,38	DIN 933 / ISO 4017	100	L-K41742
M10						
M10 x 20 VG	16	6,40	17,77	ISO 4017	100	L-K41743
M10 x 25 VG	16	6,40	17,77	ISO 4017	100	L-K41744
M10 x 30 VG	16	6,40	17,77	ISO 4017	100	L-K41745
M10 x 40 VG	16	6,40	17,77	ISO 4017	100	L-K41746
M10 x 50 VG	16	6,40	17,77	ISO 4017	100	L-K41747
M12						
M12 x 30 VG	18	7,50	20,03	ISO 4017	100	L-K41748
M12 x 40 VG	18	7,50	20,03	ISO 4017	50	L-K41749
M12 x 50 VG	18	7,50	20,03	ISO 4017	50	L-K41750
M12 x 60 VG	18	7,50	20,03	ISO 4017	50	L-K41751



NEREZ-A2

Matice šestihranná DIN 934 ušlechtilá ocel A2

svařitelná šestihranná matice z ušlechtilé oceli s vnitřním závitem dle normy; DIN 934; ušlechtilá ocel A2; závit: normální;

d1 mm	s mm	m mm	e mm		obj.č.
M6	10	5,00	11,05	500	L-K41729
M8	13	6,50	14,38	500	L-K41730
M10	17	8,00	18,90	200	L-K41731
M12	19	10,00	21,10	200	L-K41732
M14	22	11,00	24,49	50	L-K41733
M16	24	13,00	26,75	50	L-K41734

Podložka DIN 125A ušlechtilá ocel A2

podložka DIN 125A; bez fazety; ušlechtilá ocel A2;

NEREZ-A2

pro šrouby	d1 mm	d2 mm	s mm		obj.č.
M4	4,3	9,00	0,8	200	L-K41721
M5	5,3	10,00	1,0	200	L-K41722
M6	6,4	12,00	1,6	200	L-K41723
M8	8,4	16,00	1,6	200	L-K41724
M10	10,5	20,00	2	200	L-K41725
M12	13	24,00	2,5	200	L-K41726
M14	15	28,00	2,5	100	L-K41727
M16	17	30,00	3	100	L-K41728

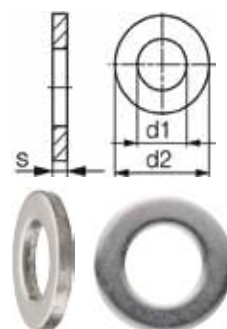

Šrouby do dřeva

Vrut do dřeva se šestihrannou hlavou DIN 571 ocel poz.

vrut do dřeva z oceli se šestihrannou hlavou (podstavcový šroub); oblast použití: dřevostavby; slouží např. napojení stavebních dílů nebo kotvení do betonu prostřednictvím hmoždinek; ocel, pozinkováno;

rozměr mm	s mm	e mm	k mm		obj.č.
6,0 mm					
6 x 40	10,00	10,89	4,00	200	L-E00781
6 x 60	10,00	10,89	4,00	200	L-E00784
6 x 80	10,00	10,89	4,00	200	L-E00786
8,0 mm					
8 x 50	13,00	14,20	5,50	200	L-E00791
8 x 60	13,00	14,20	5,50	200	L-E00792
8 x 70	13,00	14,20	5,50	200	L-E00793
8 x 80	13,00	14,20	5,50	200	L-E00794
8 x 100	13,00	14,20	5,50	100	L-E00796
10 mm					
10 x 80	17,00	18,72	7,00	100	L-E00802
10 x 100	17,00	18,72	7,00	100	L-E00804
10 x 120	17,00	18,72	7,00	50	L-E00805
12 mm					
12 x 70	19,00	20,88	8,00	50	L-E00809
12 x 80	19,00	20,88	8,00	50	L-E00810
12 x 100	19,00	20,88	8,00	50	L-E00812

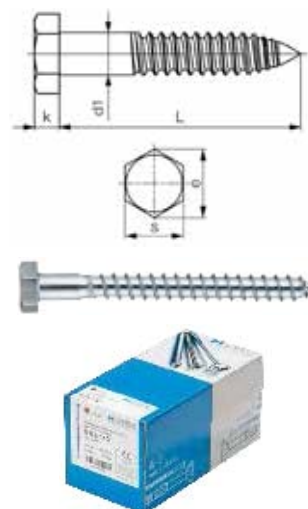

Vrut do dřevěných konst. VermoTec se zápusťnou hlavou TX ocel poz.

vrut do dřevěných konstrukcí se zápusťnou hlavou a vnitřním (TX), žebrováním pod hlavou; je dostupný s plným závitěm (VG) nebo částečným závitěm (TG); díky pohonu TX snazší šroubování;

rozměr mm	velikost TX	dk mm	b mm	k mm		obj.č.
4,0 mm						
4 x 60 TG	20	8,00	36,00	4,25	200	L-811282
4 x 70 TG	20	8,00	42,00	4,25	200	L-811285
4,5 mm						
4,5 x 60 TG	25	9,00	36,00	4,65	200	L-811294
4,5 x 70 TG	25	9,00	42,00	4,65	200	L-811300
5,0 mm						
5,0 x 40 TG	25	10,00	24,00	5,05	200	L-811372
5,0 x 50 TG	25	10,00	30,00	5,05	200	L-811374
5,0 x 60 TG	25	10,00	36,00	5,05	200	L-811381
5,0 x 70 TG	25	10,00	42,00	5,05	200	L-811384
5,0 x 80 TG	25	10,00	48,00	5,05	200	L-811385
5,0 x 90 TG	25	10,00	54,00	5,05	200	L-811387
5,0 x 100 TG	25	10,00	60,00	5,05	200	L-811389
5,0 x 120 TG	25	10,00	70,00	5,05	200	L-811390
6,0 mm						
6,0 x 60 TG	30	12,00	36,00	5,90	200	L-811392
6,0 x 80 TG	30	12,00	48,00	5,90	200	L-811396
6,0 x 100 TG	30	12,00	60,00	5,90	100	L-811399
6,0 x 120 TG	30	12,00	70,00	5,90	100	L-811401
6,0 x 140 TG	30	12,00	70,00	5,90	100	L-811403
6,0 x 160 TG	30	12,00	70,00	5,90	100	L-811405
8,0 mm						
8 x 80 TG	40	14,90	48,00	7,50	50	L-811415
8 x 100 TG	40	14,90	60,00	7,50	50	L-811419
8 x 120 TG	40	14,90	80,00	7,50	50	L-811426
8 x 140 TG	40	14,90	80,00	7,50	50	L-811430
8 x 160 TG	40	14,90	80,00	7,50	50	L-811431
8 x 180 TG	40	14,90	80,00	7,50	50	L-811434
8 x 200 TG	40	14,90	100,00	7,50	50	L-811437



Nyní nově: shop.ploberger.net

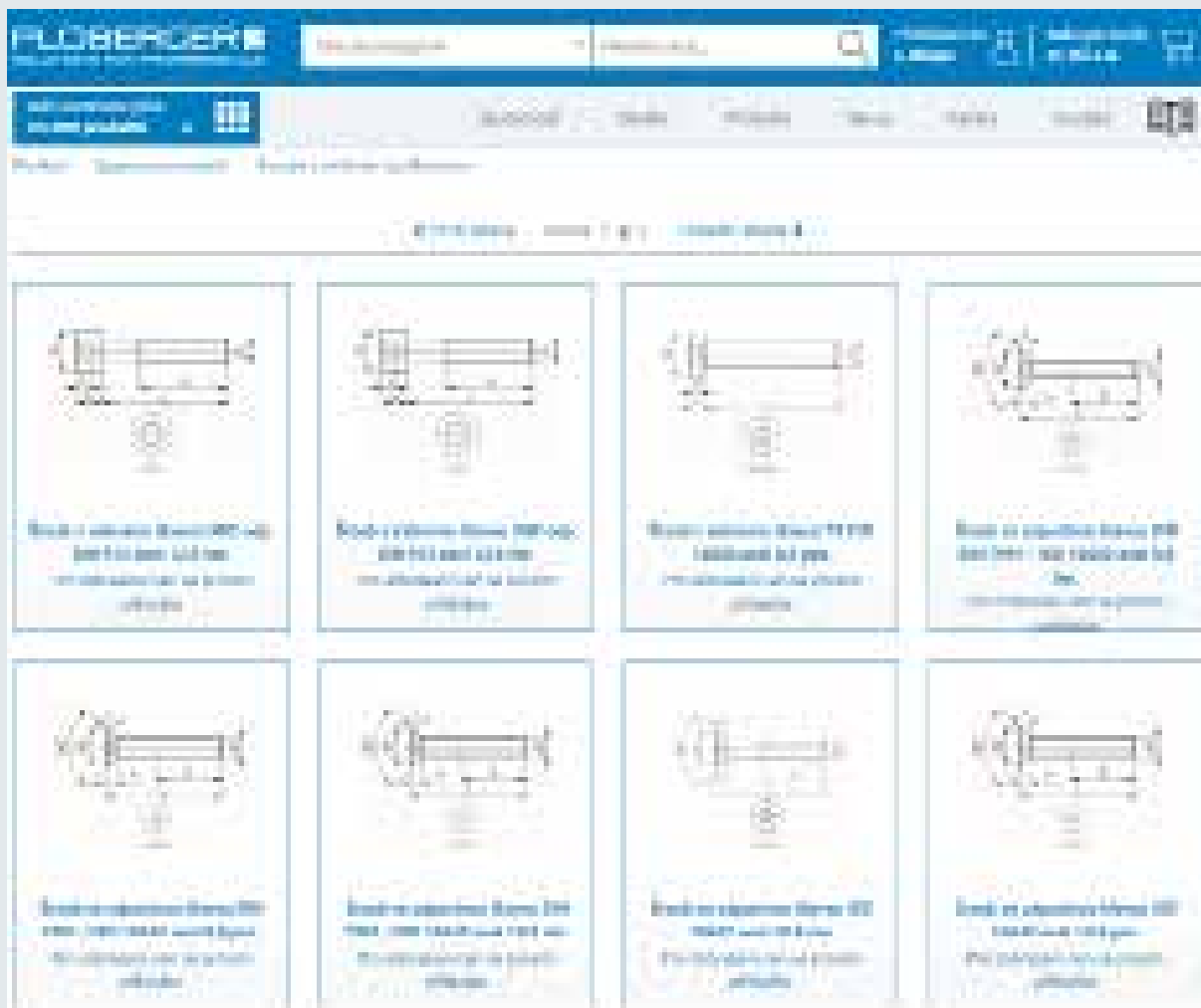

Přes 24.000 položek spoj. materiálu a normovaných dílů

Česká republika

Ploberger s.r.o.
Hakenova 31
669 02 Znojmo

Tel.: +420 515 267 367
Fax: +420 515 267 366

office@ploberger.cz
www.ploberger.cz

Rakousko

Ploberger GesmbH
Im Stadtfeld 4
A-2070 Retz

Tel.: +43 / 2942 / 3471-0
Fax: +43 / 2942 / 3471-1039

office@ploberger.net
www.ploberger.net

Slovensko

Ploberger-SK s.r.o.
Priemyselná 1
SK-909 01 Skalica

Tel.: +421 / 346 / 941 271
Fax: +421 / 346 / 941 270

office@ploberger.sk
www.ploberger.sk

PLOBERGER 
SOLUTIONS FOR PROFESSIONALS